

KÖNIG TOOLS®

MATERIAL GERMANY

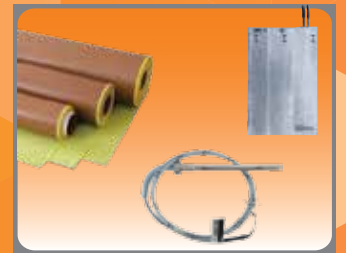
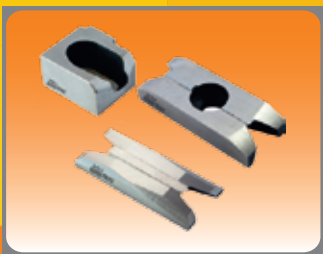

Официальный дистрибьютор в России

2017



T&T
TEKNİK TESTERE A.Ş.

ОРП
Сервис

📍 Arapcami Mah. Bakır Sokak Aslan Han No:1
Kat: 5 / 510 Karaköy - ISTANBUL - TURKIYE

☎ Tel: +90 212 237 90 80

📠 Fax: +90 212 237 01 75

📱 GSM: +90 532 406 69 00 WhatsApp/Viber

📱 GSM: +7 926 640 21 82 WhatsApp/Viber

✉ E-mail: emirveli@gmail.com

🌐 www.tekniktestere.com.tr

📍 Обслуживание Ремонт Продажа
Оборудования для производства ПВХ окон
фрезы Сверла Пильные диски Запчасти
г. Москва, ул. Полярная, д. 41, стр. 1, оф. 302В

☎ Телефон/факс: (495) 545-45-81/82; 540-55-81

📠 Бесплатная горячая линия: 8-800-333-11-81

🌐 www.zip-ok.ru

✉ Эл. почта: info@orp-service.ru; info@orp-s.ru

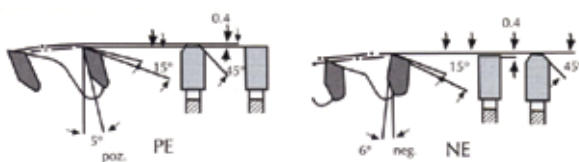
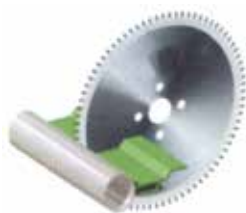

Neg (Negativ): отрицательный угол заточки на 5
Отрицательный угол образуется между передней режущей кромкой зуба и линией, проведенной от центра диска к передней режущей кромке зуба. Для отрезания пластиковых и алюминиевых профилей до 3 мм со скосом под углом 45.

Pos (POSITIVE): положительный угол заточки зуба. Положительный угол образуется между передней режущей кромкой зуба и линией, проведенной от центра диска к передней режущей кромке зуба.

Артикул	D	B	D	Z
ALM-115-01	115	4,0	22	20
ALM-140-01	140	2,4	30	48
ALM-160-01	160	2,2	30	48
ALM-170-01	170	3,0	30	48
ALM-180-01	180	3,0	30	48
ALM-180-02	180	3,0	30	58
ALM-190-01	190	2,0	30	58
ALM-190-02	190	3,0	30	58
ALM-200-01	200	3,0	30	40
ALM-200-02	200	3,0	30-32	64
ALM-200-03	200	2,0	30-32	64
ALM-210-01	210	2,0	30	64
ALM-210-02	210	3,0	30	64
ALM-230-01	230	3,0	30	36
ALM-230-02	230	3,2	30	72
ALM-235-03	235	3,0	30	30
ALM-250-01	250	3,2	30-32	60
ALM-250-02	250	3,2	30-32	80
ALM-250-03	250	2,0	30	80
ALM-270-01	270	2,4	30	48
ALM-270-02	270	3,0	30	88
ALM-275-01	275	2,4	30	48
ALM-280-01	280	2,5	30	64
ALM-280-02	280	3,2	30	88
ALM-300-01	300	3,2	30	48
ALM-300-02	300	3,2	30	60
ALM-300-03	300	3,2	30-32	72
ALM-300-04	300	3,2	30-32	96
ALM-300-05	300	2,0	30-32	96
ALM-305-01	305	3,2	30	96
ALM-320-01	320	3,2	32	96
ALM-330-01	330	3,6	32	108
ALM-350-01	350	3,6	30-32	84
ALM-350-02	350	3,6	30-32	96
ALM-350-03	350	3,6	30-32	108

Артикул	D	B	D	Z
ALM-355-01	355	2,0	30	50
ALM-380-01	380	3,6	30	56
ALM-380-02	380	3,6	32	112
ALM-400-01	400	4,0	30	60
ALM-400-02	400	4,0	30	72
ALM-400-03	400	4,0	30-32	96
ALM-400-04	400	4,0	30-32	108
ALM-400-05	400	4,0	30-32	120
ALM-420-01	420	2,8	30	60
ALM-420-02	420	4,0	30	72
ALM-420-03	420	2,8	30	80
ALM-420-04	420	4,0	30-32	96
ALM-420-05	420	4,0	30-32	108
ALM-420-06	420	4,0	30-32	120
ALM-450-01	450	4,0	30	72
ALM-450-02	450	4,0	30	96
ALM-450-03	450	4,0	30-32	108
ALM-450-04	450	4,0	32	120
ALM-500-01	500	4,0	30	60
ALM-500-02	500	4,0	30	72
ALM-500-03	500	4,0	40	96
ALM-500-04	500	4,0	30	108
ALM-500-05	500	4,0	30-32	120
ALM-500-06	500	4,0	30	138
ALM-500-07	500	4,0	30	160
ALM-505-01	505	4,0	30	120
ALM-550-01	550	4,4	50	68
ALM-550-02	550	4,4	30	72
ALM-550-03	550	4,4	30	96
ALM-550-04	550	4,4	30-32	120
ALM-600-01	600	4,4	50	72
ALM-600-02	600	4,4	30	96
ALM-600-03	600	4,4	30	120
ALM-600-04	600	4,4	30	140
ALM-600-05	600	4,4	30	160



Фрезерные пилы для резки ПВХ штапика (CRV)

Артикул	D	B	D	Z
СК-200-03	200	1,8	32	160
СК-250-01	250	2,0	32	100
СК-250-02	250	2,5	32	100
СК-300-01	300	2,5	32	120

Пильные диски для резки пластика (CRV)

Артикул	D	B	D	Z
PVC-200-01	200	1,3	32	180
PVC-250-01	250	1,3	32	230
PVC-300-01	300	1,3	32	280
PVC-350-01	350	1,3	32	360
PVC-400-01	400	1,3	40	410

Подрезные пилы для резки штапика 45° (HSS)

Артикул	D	B	D	Z
FRZ-95-01	95	1,8	32	80
FRZ-95-03	95	2,5	32	80
FRZ-100-03	100	3,0	32	80
FRZ-100-01	100	4,0	22	80
FRZ-100-02	100	4,0	32	80
FRZ-103-01	103	2,0	32	80
FRZ-110-01	110	4,0	20	80
FRZ-115-01	115	4,0	22	80
FRZ-120-01	120	4,0	22	80
FRZ-120-02	120	4,0	27	80
FRZ-125-01	125	4,0	22	80

Фрезерный пилы для резки ПВХ и алюминиевого штапика (HM)

Артикул	D	B	D	Z	YÖN
EUT-175-01	175	2,1	20	68	pos-WZ
EUT-200-01	200	2,1	30	60-100	neg
EUT-200-02	200	2,2	30-32	100	neg
EUT-200-03	200	2,1	32	80-100	neg-pos
EUT-225-01	225	2,2	32	88-100	neg
EUT-250-01	250	2,1	20	120	neg

подрезные пилы для резки пвх штапика 45° (HM)

Артикул	D	B	D	Z	YÖN
EFT-92-01	95	1,8	32	80	L/R
EFT-95-01	95	2,5	32	80	L/R
EFT-98-01	100	3,0	32	80	L/R
EFT-103-01	100	4,0	22	80	L/R
EFT-103-02	100	4,0	32	80	L/R
EFT-150-01	103	2,0	32	80	L/R
EFT-175-01	110	4,0	20	80	L/R

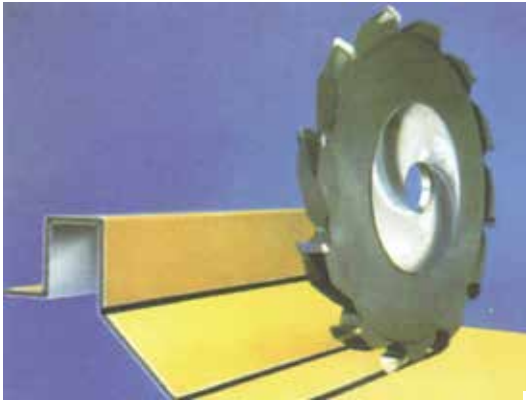

АРТИКУЛ	D	B	d	Z
ALC-150-01	150	8,0	30	18
ALC-150-02	150	10,0	30	18
ALC-180-01	180	8,0	30	18
ALC-180-02	180	8,5	30	18
ALC-180-03	180	10,0	30	18
ALC-180-04	180	8,0	30	24
ALC-180-05	180	10,0	30	24
ALC-200-01	200	8,0	30	18
ALC-200-02	200	8,5	30	18
ALC-200-03	200	10,0	30	18
ALC-200-04	200	8,0	30	24
ALC-200-05	200	10,0	30	24

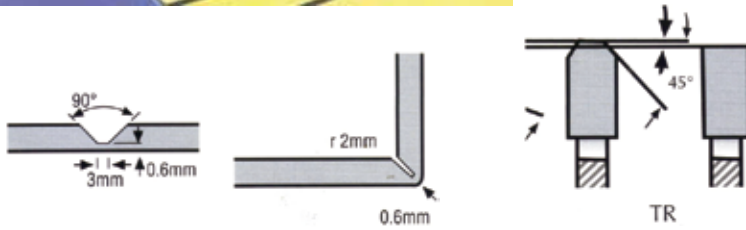

Пильные диски для зачистки торца импоста (Polar 1, Polar 2, Aldox, Festool)



ÖZÇELİK POLAR 1
YILMAZ ALDOX

АРТИКУЛ	D	B	d	Z
KRT-86-02	86	4.5	30	10
KRT-87-02	87	4.3	30	10
KRT-120-01	120	5.2	30	14
KRT-127-01	127	4.5	30	12
KRT-128-01	128	4.5	30	12
KRT-162-01	161	6.0	30	18

Пильные диски для резки металла и сэндвич-панелей (DRY CUT)

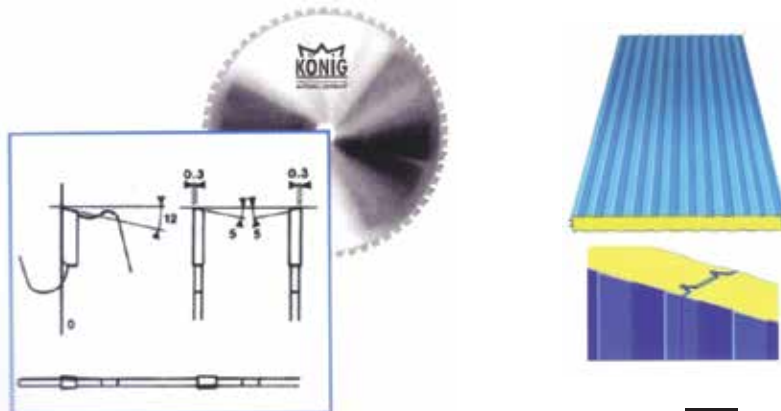

D	B	d	Z
180	2.2	20	34
190	2.2	20	38
210	2.2	30	40
230	2.2	30	44
305	2.2	25.4	80
355	2.4	25.4	80

ДИСКОВАЯ ФРЕЗА ДЛЯ ОБРАБОТКИ КОНТУРА ВНЕШНЕГО УГЛА

АРТИКУЛ	D	B	d	Z
CNC-250-01	250	4,5/3,5	20	56+8



ДИСКОВАЯ ФРЕЗА ДЛЯ ОБРАБОТКИ КОНТУРА ВНЕШНЕГО УГЛА

АРТИКУЛ	D	B	d	Z
CNC 230-1	230	4,5/3,5	20	54+6 FZ



ДИСКОВАЯ ФРЕЗА ДЛЯ ОБРАБОТКИ КОНТУРА ВНЕШНЕГО УГЛА

АРТИКУЛ	D	B	d	Z / Высота зубьев
CNC-250-3	250	5/4	32	Z68/11,55



ДИСКОВАЯ ФРЕЗА ДЛЯ CNC ЗАЧИСТНОГО СТАНКА URBAN SV 405, URBAN SV 410, URBAN SV 430, URBAN SV 530, URBAN SV 800

АРТИКУЛ	D	B	d	Z / Градус заточки
CNC-250-02	250	5,0/3,6	32	32/-5



ДИСКОВАЯ ФРЕЗА ДЛЯ CNC ЗАЧИСТНОГО СТАНКА URBAN

АРТИКУЛ	D	B	d	Z / Высота зубьев
CNC-250-4	250	5,0	32	32/17



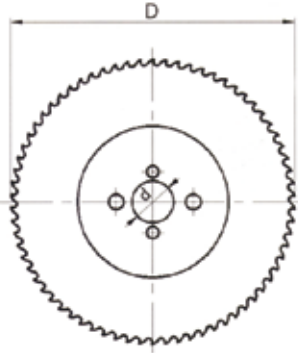

EXTREME

D(mm)	B(mm)	d(mm)
225	1,80	32
250	2,00	32
275	2,00	32
275	2,50	32
300	2,50	32-40
315	2,00	32-40

HSS/E

D(mm)	B(mm)	d(mm)
225	1,80	32
250	2,00	32
275	2,00	32
275	2,50	32
300	2,50	32-40

D(mm)	B(mm)	d(mm)
200	1,60	32
200	1,80	32
200	2,00	32
210	1,60	32
225	2,00	32
225	1,80	32
250	1,20	32
250	1,60	32
250	2,00	32-40
250	2,50	32-40
275	2,00	32
275	2,50	32-40
275	3,00	32-40
300	2,00	32-40
300	2,50	32-40
300	3,00	32-40
315	2,00	32-40
315	2,50	32-40
315	3,00	32-40
325	2,00	32-40-50
325	2,50	32-40-50
350	2,00	32-40-50
350	2,50	32-40-50
350	3,00	32-40-50
370	4,00	40-50
400	3,00	40-50
400	3,50	40-50
400	4,00	40-50
425	3,00	40-50
425	3,50	40-50
425	4,00	40-50
450	3,00	40-50
450	3,50	40-50
450	4,00	40-50
500	4,00	40-50

Диски для резки бумаги и ткани



CRV

Code No	D	B	d
BA-200-01	200	2,0	32
BA-250-02	250	2,5	32
BA-300-01	300	2,5	32
BA-350-01	350	2,5	32
BA-400-01	400	3,0	40
BA-400-02	400	4,0	40
BA-450-01	450	4,0	40
BA-520-01	520	3,0	40
BA-520-02	520	4,0	40
BA-520-03	520	5,0	40
BA-600-01	600	4,0	40
BA-600-02	600	5,0	40



Размер (мм)	На один шаг количество зубьев
6 x 0,90	6 - 8 - 10 - 14 - 10 / 14
10 x 0,90	6 - 8 - 10 - 14 - 10 / 14
13 x 0,65	6 - 8 - 10 - 14 - 8 / 12 - 10 / 14
13 x 0,90	6 - 8 - 10 - 14 - 8 / 12 - 10 / 14
20 x 0,90	4 - 6 - 8 - 10 - 14 - 6 / 10 - 8 / 12 - 10 / 14
27 x 0,90	3 - 4 - 6 - 8 - 14 - 2 / 3 / 4 / 6 / 5 / 8 - 6 / 10 - 10 / 14
34 x 1,10	3 - 4 - 6 - 2 / 3 / 4 - 4 / 6
41 x 1,30	2 - 3 - 4 - 6 - 2 / 3 - 3 / 4 - 4 / 6
54 x 1,60	2 - 3 - 2 / 3 - 3 / 4
67 x 1,60	2 - 3 - 2 / 3 - 3 / 4



Ленточные пилы по металлу из карбоновой стали



Размер (мм)	На один шаг количество зубьев
4 x 0,65	10 - 14 - 18 - 24
6 x 0,65	10 - 14 - 18 - 24
8 x 0,65	10 - 14 - 18
10 x 0,65	8 - 10 - 14 - 18
13 x 0,65	8 - 10 - 14 - 18
16 x 0,80	6 - 8 - 10 - 14
20 x 0,80	6 - 8 - 10 - 14
25 x 0,90	3 - 4 - 6 - 8 - 10 - 14



Артикул	D	B	d	Z
PRF-200-01	200	2.0	32	124
PRF-250-02	250	2.5	32	156
PRF-300-01	300	2.5	32	186
PRF-350-01	350	2.5	32	216
PRF-400-01	400	3.0	40	230
PRF-400-02	400	4.0	40	230
PRF-450-01	450	3.0	40	260
PRF-450-02	450	4.0	40	260
PRF-520-01	520	3.0	40	300
PRF-520-02	520	4.0	40	300
PRF-520-03	520	5.0	40	300
PRF-600-01	600	4.0	40	300
PRF-600-02	600	5.0	40	240-280-300
PRF-700-01	700	5.0	40	280-328-350
PRF-700-02	700	6.0	40	280-328-350
PRF-800-01	800	5.0	40	320-382-400
PRF-800-02	800	6.0	40	320-372-400

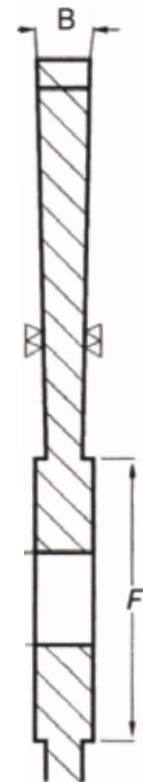

Артикул	D	B	d	d1
TT 100312608	3,0	12	60	8,0
TT 100412608	4,0	12	60	8,0
TT 10414606	4,0	14	60	6,0
TT 104201208	4,0	20	120	8,0
TT 100512606	5,0	12	60	6,0
TT 100512608	5,0	12	60	8,0
TT 100518608	5,0	18	60	8,0
TT 100525708	5,0	25	70	8,0
TT 1005251008	5,0	25	100	8,0
TT 1005401008	5,0	40	100	8,0
TT 105141208	5,0	14	120	8,0
TT 100614608	6,0	14	60	8,0
TT 100616608	6,0	16	60	8,0
TT 10716608	7,0	16	60	8,0

Артикул	d	l	l1	L	d1
TT 241645908	4,0	16	45	90	8,0
TT 251835806	5,0	18	35	80	6,0
TT 251835808	5,0	18	35	80	8,0
TT 251645908	5,0	16	45	90	8,0
TT 2518351008	5,0	18	35	100	8,0
TT 2525551008	5,0	25	55	100	8,0
TT 2514751208	5,0	14	75	120	8,0
TT 2518351208	5,0	18	35	120	8,0
TT 261435808	6,0	14	35	80	8,0
TT 2618351008	6,0	18	35	100	8,0
TT 281454808	8,0	14	54	80	8,0
TT 28307001008	8,0	30	70	100	8,0
TT 2814901208	8,0	14	90	120	8,0
TT 21025459010	10,0	25	45	90	10,0
TT 210307010010	10,0	30	70	100	10,0
TT 2149512010	10,0	14	95	120	10,0

Артикул	d	l	L	d1
TT 300614606	6,0	14	60	6,0
TT 300816808	8,0	16	80	8,0
TT 3008141008	8,0	14	100	8,0
TT 3008141208	8,0	14	120	8,0
TT 3008281208	8,0	28	120	8,0
TT 300914808	9,0	14	80	8,0
TT 3001014808	10,0	14	80	8,0
TT 300101412010	10,0	14	120	10,0
TT 3001214808	12,0	14	80	8,0



Фреза для обработки композитных панелей 90°



d1 mm	L1mm	d2 mm
18	50	8

**Фреза для бормашинки
4,2 x 60 x 6**



КТ 01

MURAT



Ø 12x15x100x12 HSS-E
Фреза для каналов дверного привода

КТ 02

MURAT



Ø 12x16x100x12 HSS-E
Фреза для каналов дверного привода

КТ 03

MURAT



Ø 12x15x100x12 HSS-E
Ступенчатое сверло

КТ 03-1

MURAT



Ø 3x20x133x12 HSS-E
Ступенчатое сверло

КТ 04

MURAT



Ø 7x20x133x12 HSS-E
Ступенчатое сверло

КТ 05

MURAT



Ø 3x14x132.5x12 HSS-E
Ступенчатое сверло

КТ 05-1

MURAT



Ø 3.5x12x132.5x12 HSS-E
Ступенчатое сверло

КТ 05-2

MURAT



Ø 3.5x13x132.5x12 HSS-E
Ступенчатое сверло

КТ 05-3

MURAT



Ø 3.5x14x132.5x12 HSS-E
Ступенчатое сверло

КТ 05-4

MURAT



Ø 3.5x16x132.5x12 HSS-E
Ступенчатое сверло

KT 06 MURAT



Ø 3x5x25x55x100x8 HSS-E
Фреза для водоотливных каналов

KT 06-1 MURAT



Ø 3x5x25x55x100x8 HM
Фреза для водоотливных каналов а

KT 07 MURAT



Ø 3x5x25x70x8 Z1 HSS-E
Фреза для водоотливных каналов

KT 07-1 ÖZGENÇ



Ø 7x25x100x7 HSS-E
Двух заходная фреза

KT 08 MURAT



Ø 8x27x6.5x Z4 HSS-E
Четырёх заходная фреза

KT 09 MURAT



Ø 6.5x30.85x6 Z2 HSS-E
Фреза для водоотливных каналов

KT 10 MURAT



Ø 17x6.07x79x6.5 Z4 HSS-E
Четырёх заходная фреза

KT 11 MURAT



Ø 12x26x83x12 Z2 HM
Двух заходная фреза

KT 12 MURAT



Ø 5x25x40x80x8 HM
Фреза для водоотливных каналов

KT 12-1



Ø 6x20x50x6 HM

KT 13

MURAT



Ø 5x30x55x95x8 HM
Ступенчатое сверло

KT 13-1

MURAT



Ø 5x30x55x95x8 Z2 HM
Двух заходная твердосплавная фреза

KT 13-2

MURAT



Ø 5x20(30)x65x8 Z2 HM
Двух заходная твердосплавная фреза

KT 13-3

MURAT



Ø 5x40(50)x95x8 Z2 HM
Двух заходная твердосплавная фреза

KT 14

KABAN



7x15x90x6 Old
7x15x90x7 New
Двух заходная фреза

KT 15

KABAN



Ø 5.2x28x80x8 HSS-E
Ступенчатое сверло

KT 16

KABAN



Ø 5x40x80x8 HSS-E
Ступенчатое сверло

KT 17

KABAN



6x40x80x8 HSS-E
Ступенчатое сверло

KT 18

ELUMATEC



10x35x60x100x10 Z2 HSS-E
Ступенчатое сверло

KT 18-1

ELUMATEC



10x35x100x10 Z2 HSS-E
Двух заходная фреза

KT 19

KABAN



Ø 15.1x8x83 Z4 HSS-E
Четырех заходная фреза

KT 20

KABAN



Ø 5x40x80x8 HM
Фреза для водоотливных каналов

KT 21

KABAN



Ø 6x40x80x8
Фреза для водоотливных каналов

KT 22

MURAT - SCHTEK



Ø 8x30x85x6 Z2 HSS-E
Двух заходная фреза

KT 23

ELUMATEC, STÜRTZ



Ø 5x40x80x5 Z1
Однозаходная пальчиковая фреза HM

KT 23-1

ELUMATEC, STÜRTZ



Ø 6x40x80x6 HM
Однозаходная пальчиковая фреза HM

KT 24

ELUMATEC, STÜRTZ



Ø 12x3.5x18x5x100x6 Z4
Четырех заходная фреза

KT 25

ELUMATEC, STÜRTZ



Ø 12x3.5x18x5x100x8 Z4
Четырех заходная фреза

KT 26

ELUMATEC, STÜRTZ



Ø 7.5x25x95x6 Z2 HSS-E
Двух заходная фреза

KT 27

ELUMATEC, STÜRTZ



Ø 7.5x20x75x6 Z2 HM
Двух заходная фреза

KT 28

ELUMATEC, STÜRTZ



Ø 14x45x100x8 Z2 HM
Двух заходная фреза

KT 29

ELUMATEC, STÜRTZ



Ø 8x2.0x4x20x8 Z4 HM
Четырёх заходная фреза

KT 29-1

ELUMATEC, STÜRTZ



Ø 8x4x15x4x100x6 Z3 HM
Трёх заходная фреза

KT 30

ELUMATEC, STÜRTZ



Ø 5x40x80x8 HM
Фреза для водоотливных каналов

KT 31

ELUMATEC, STÜRTZ



Ø 5x40x80x8 HM
Фреза для водоотливных каналов

KT 32

ELUMATEC, STÜRTZ



Ø 5x30x80x8 HM
Фреза для водоотливных каналов

KT 32-1

ROTOX



Ø 8.5x31x100x8 Z2 HM
Двух заходная фреза

KT 33

ELUMATEC, STÜRTZ



Ø 6x24x68x6 Z2 HSS-E
Двух заходная фреза

KT 34

ELUMATEC, STÜRTZ,
URBAN, WEGOMA, ROTOX



Ø 10x30x60x M10 HSS-E
Сверло (левое)

KT 35

ELUMATEC, STÜRTZ,
URBAN, WEGOMA, ROTOX



Ø 12x30x60 M10 HSS-E
Сверло (левое)

KT 36

ELUMATEC, STÜRTZ,
URBAN, WEGOMA, ROTOX



Ø 10x30x60 M10 HSS-E
Сверло правое

KT 37

ELUMATEC, STÜRTZ,
URBAN, WEGOMA, ROTOX



Ø 12x30x65 M10 HSS-E
Сверло правое

KT 37-1

ELUMATEC, STÜRTZ,
URBAN, WEGOMA, ROTOX



Ø 6x10x87 M10 HSS-E
Сверло (левое)

KT 37-2

ELUMATEC, STÜRTZ,
URBAN, WEGOMA, ROTOX



Ø 6x12x87 M10 HSS-E
Сверло (левое)

KT 37-3

ELUMATEC, STÜRTZ,
URBAN, WEGOMA, ROTOX



Ø 6x10x84 M10 HSS-E
Сверло правое

KT 37-4

ELUMATEC, STÜRTZ,
URBAN, WEGOMA, ROTOX



Ø 6x12x84 M10 HSS-E
Сверло правое

KT 38

GRAF



Ø 5x35x44x100x8 HM

KT 39

GRAF



Ø 3x5x30x50x100x8 HM

KT 40

GRAF



Ø 12x60x110x12 Z2 HM
Сверло

KT 41

GRAF



Ø 12x50x100x12 Z3 HM
Сверло

KT 42

GRAF



Ø 12x50x100x12 Z4 HM

KT 43

ARTIKON - SETİNO



DG 603 Ø 11x40x120 / 21x19x80 HSS-E

KT 43-1

ARTIKON - SETİNO



Ø 4.3x70x113x19 Z2 HSS-E

KT 44



Ø 16 HM

Фреза для обработки композитных панелей (твердослав)

KT 44-1



Ø 10x25x61x10 Z2 HM

Фреза для обработки композитных панелей (твердослав)

KT 45



Ø 3x32x80x8 Z1

KT 46

URBAN



Ø 12x3.8x6.2x100x8 Z2 HM

KT 47

URBAN



Ø 12x3.8x6.2x64.2x100x8 Z4 HM

KT 48

KMW



Ø 10x3x4.5x12x160x8 Z4 HM

KT 49



Ø 5x16x68x5 Z2 HM

Двух заходная фреза

KT 50



Ø 7.5x25x75x6 HM
Двух заходная фреза

KT 51

FOM



Ø 5x25x55x100x8 HM

KT 52



Ø 8x5x30x100x6 Z3 HM

KT 53



Ø 2.5x33x76x6 HM

KT 54

FOM



Ø 10x40x65x110x10 HM
Однозаходная твердосплавная фреза

KT 55



Ø 8x52x100x8 Z4 HM

KB 01



Ø 12x26x83 Z4 HSS-E

KB 03



Ø 12x26x83 Z4 HSS-E

KB 05



Ø 10x45x95 Z4 HSS-E

KB 06-1



Ø 12x33x74x12 Z4

KB 08



Ø 12x26x83x10 Z4 HSS-E

KB 02



Ø 12x55x110 Z4 HSS-E

KB 04



Ø 12x55x110 Z4 HSS-E

KB 06



Ø 14x26x83 Z4 HSS-E

KB 07



Ø 8x15x55x93x12 Z4 HSS-E

KB 09



Ø 12x73x136x12 Z4 HSS-E

KB 10



Ø 16x63x97x10 Z4 HSS-E

KB 11



комплект фрез для грубой обработки Artikon Setino DG 604

KB 12



Ø 4.5x11x11x100x140x10 Z2 HM

KB 13



Ø 15x72x110x10 Z2 HM

AP 01



75mm Ph-2

AP 02



45mm Ph-2

AP 03

SCHTEK - MURAT



150mm Ph-2

AP 03-1

SCHTEK - MURAT



152mm Ph-2

AP 04

KABAN



EA 1010, EA 1030, DE 4070, DE 4080 175mm

AP 05

KABAN



EK 1040 91mm

AP 06

ELUMATEC



ADS 259 175mm

AP 06-1

ELUMATEC



145mm

AP 07

MURAT



KT 804 220mm

AP 08

MURAT



DV 404 175mm

AP 09

ARTİKON, SETİNO



160mm

AP 10

ARTİKON, SETİNO



140mm

AP 10-1

SCHTEK - MURAT



197mm Ph-2

AP 11

İNO



220 mm

AP 12

İNO



175mm

AP 13

FİMTEK



175mm

AP 14

STB



175mm

AP 15

MURAT



Головка в сборе и комплект губ для шуруповерта

AP 16

ELUMATEC



Головка в сборе и комплект губ для шуруповерта

MT 01

MURAT



5x11x90
5x11x95
5X12x100

MT 02

MURAT



5X10X100
5X10X100
6X12X84
M-6

MT 03

ÖZÇELİK



5X10X100
5X10X100
6X12X84

MT 04

ELUMATEC



6x10x90
6x12x86.5
6x10x90
M-10

MT 05

ELUMATEC



5x10x115
5x12x115
5x10x115
M-10

MT 06

STB / FİMTEC



5x10x87
5x12x87
5x12x87
M-10

MT 07

KABAN



5.5x11x86
5.5x11x86
5.5x13x89

MT 08

KABAN



5.5x 11x107
5.5x11x110
5.5x13x115

MT 08-1

KABAN



5.5x 11x107
5.5x11x110
5.5x13x115

MT 09

KABAN



5.5x11x110
5.5x11x110
5.5x13x115
M-8

MT 10

YILMAZ



6x10x117
6x10x117
6x13x120
MT-8 Vidalı

MT 11

YILMAZ



6x10x107
6x10x107
6x13x110
MT-8 Veldon

MT 12

TAHA BAYRAK



6x11x140
6x11x140
6x13x150
MT-10 Vidalı

MT 13

ÖZGENÇ



5.5x11x115
5.5x11x115
5.5x12x120 Veldon

MT 14

ÖZGENÇ



5.5x11x140
5.5x11x140
5.5x12x140
MT-8 Vidalı

MT 15

ÖZGENÇ



5.5x11x140 M-8
5.5x11x140 M-8
5.5x13x140 M-10 Vidalı

MT 16

PENMAK



6x10x115
6x10x115
6x13x120 Veldon

MT 16-1

PENMAK



6x13x100
6x13x100
6x13x130
MT-10 Vidalı

MT 17

SÖNMEZ



5.5x11x115
5.5x11x115
5.5x13x120 Veldon

MT 18

SEÇMAK



5.5x11x140
5.5x11x140
5.5x12x150

MT 19

SAWIN



5.5x11x144
5.5x11x144
5.5x13x155 Veldon

MT 19-1

SAWIN



5x10x140
5x10x140
5x12x145 Veldon

MT 19-2

SAWIN



5x10x140
5x10x140
5x12x145 Veldon

MT 20

HEGSAN



5x10x115
5x10x115
5x13x120 Veldon

MT 21

ETM



5x10x127
5x10x127
5x12x125 Veldon

MT 22

BRÖGEN (SELİM AYKIRCA)



6x11x140
6x11x140
6x13x150 Veldon

MT 23

DAIZER (RISUS)



5x10x120
5x10x120
5.5x12x125
MT-8 Vidalı

MT 24

ARTIKON / SETİNO (yeni)



5X11X100
5X11X105
5X12X110 Veldon

MT 25

ARTIKON / SETİNO (eski)



5x10x90
5x10x95
5x12x100 Veldon

MT 26

NİKMAK



6x10x107
6x10x107
6x13x110 Veldon

MT 27

TEZELMAK



5.5x10x96
5.5x10x96
6x13x94 Veldon

MT 28

OMURZAK



5x10x125
5x10x125
6x12x130
MT-8 Vidalı

MT 29

OMURZAK



5x10x125
5x10x125
6x12x130
MT-8 Vidalı

MT 30

OMURZAK



5x10x115
5x10x115
6x12x110 Veldon

MT 31

ATLAS



6x12x150
6x12x150
6x12x150 Veldon

MT 32

SCHIRMER HAFFNER



5.5x10x87
5.5x10x87
5.5x12x87
MT-10 Vidalı

MT 33

PERTİCİ MAKİNE



5.5x10x94
5.5x10x94
5.5x12x98
MT-10 Vidali

MT 34

MLA MAKİNE



5.5x10x95
5.5x10x95
5.5x12x95
MT-10 Vidali

MT 35

SCHTEK MAKİNE



6x10x107
6x10x107
5x12x100 Veldon

MT 36

TİTİZ MAKİNE



5.5x11x115
5.5x11x115
5.5x13x120 Veldor

YT 01

MURAT



Для белых профилей

YT 02

MURAT



Для цветных профилей

YT 02-1

SCHTEC

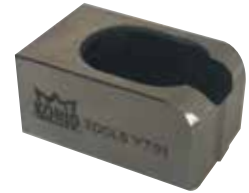

Для белых профилей

YT-02-2

SCHTEC



Для внутренней зачистки

YT 03

MURAT



Для белых профилей

YT 03-1

MURAT



Для белых профилей

YT 03-2

MURAT



Для белых профилей

YT 04

MURAT



Для цветных профилей

YT 05

MURAT



Для белых профилей

YT 06

MURAT



Для белых профилей

YT 07

MURAT



Для внутренней зачистки

YT 07-1

MURAT



Для белых профилей

YT 08

KABAN



Для белых профилей

YT 09

KABAN



Для белых профилей

YT 10

KABAN



Для белых профилей

YT 10-1

KABAN



Для белых профилей

YT 11

KABAN



Для цветных профилей

YT 12

KABAN



Нож

YT 13

KABAN



Нож

YT 13-1

KABAN



Для цветных профилей

YT 14

YILMAZ



Для белых профилей

YT 14-1

YILMAZ



Для белых профилей

YT 15

YILMAZ



Для белых профилей

YT 15-1

YILMAZ

3,5 mm



Для белых профилей

YT 15-2

YILMAZ



Для цветных профилей

YT 16

YILMAZ



Для внутренней зачистки

YT 17

ÖZÇELİK



Для белых профилей

YT 18

ÖZGENÇ



Для белых профилей

YT 19

ETM



Для белых профилей

YT 20

PENMAK



Для белых профилей

YT 21

WEGOMA



Для белых профилей

YT 22

WEGOMA



Для цветных профилей

YT 23

WEGOMA



Для внутренней зачистки

YT 24

URBAN-TİTİZ ATLAS



Для белых профилей

YT 24-1

URBAN



Для внутренней зачистки

YT 25

ELUMATEC



Для белых профилей

YT 25-1

ELUMATEC



Для цветных профилей

YT 25-2

ELUMATEC



Для белых профилей

YT 25-3

ELUMATEC



Для внутренней зачистки

YT 26

ELUMATEC



Для внутренней зачистки

YT 27

ELUMATEC



Для белых профилей

YT 28

ELUMATEC



Для цветных профилей

YT 29

ELUMATEC



Для белых профилей

YT 29-1

ELUMATEC



Для внутренней зачистки

YT 29-2

ELUMATEC



Для внутренней зачистки

YT 29-3

ELUMATEC



Для белых профилей

YT 29-4

ROTOX



Для внутренней зачистки

YT 29-5

ROTOX



Для внутренней зачистки

YT 29-6

ROTOX



Для белых профилей

YT 29-7

STÜRTZ



Для белых профилей

YT 29-8

PROFTEQ



Для белых профилей

YT 29-9

PROFTEQ



Для белых профилей

YT 29-10

MLA



Для белых профилей

YT 30

SELİM AYKIRCA (BRÖGEN)



Для белых профилей

YT 31

EFOR



Для белых профилей

YT 32

RİSUS (DAİZER)



Для белых профилей

YT 33

RİSUS (DAİZER)



Для внутренней зачистки

YT 34

RİSUS (DAİZER)



Для внутренней зачистки

YT 35

RİSUS (DAİZER)



Для цветных профилей

YT 36

RİSUS (DAİZER)



Для белых профилей

YT 36-1

RİSUS (DAİZER)



Для внутренней зачистки

YT 36-2

RİSUS (DAİZER)



Для внутренней зачистки

YT 37

MURAT



Нож клиновидный по алюминию (короткий)

YT 37-1

MURAT



Нож клиновидный по алюминию (короткий)

YT 38

TOSKAR



Для белых профилей

YT 39

ARTİKON-SETİNO



Для внутренней зачистки

YT 40

ARTİKON-SETİNO



Для белых профилей

YT 41

ARTİKON-SETİNO



Для цветных профилей

YT 42

NIKMAK



Для белых профилей

YT 43

PC 750



Для белых профилей

YT 44

PC 200



Для белых профилей

YT 44-1

AP 01



Для белых профилей

YT 44-2

AP01-1

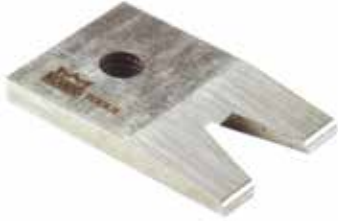

Для белых профилей

YT 44-3

AP01-2



Для белых профилей

YT 44-4

AP 03-AP 09



Для белых профилей

YT 44-5

AP 05



Зачистная фреза

YT 44-6

AP 04



Зачистная фреза

YT 44-7

AP 07



Для белых профилей

YT 44-8

UAT 2020



Зачистная фреза

YT 44-9

AP 06



Зачистная фреза

YT 45

FORZA



Для белых профилей

YT 46

ÖZTÜM (ANTEC)



Для белых профилей

YT 47

ÖZTÜM (ANTEC)



Для белых профилей

YT 48

DON CARLOS



YT 49

BURAK



Для белых профилей

YT 50

BAŞ



Для белых профилей

YT 51

URBAN-TİTİZ-ATLAS



Для белых профилей

YT 52

DİNÇTUR



Для белых профилей

YT 53

GRAF



Для цветных профилей

YT 54

GRAF



Для цветных профилей

YT 55

FİMTEC



Для белых профилей

YT 56

HAFNER

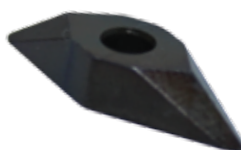

Для внутренней зачистки

YT 57

GRAF



Для внутренней зачистки

YT 58

GRAF



Для внутренней зачистки

YT 59

ÖZGENÇ



Для внутренней зачистки

YT 60

OMURZAK



Для белых профилей



Фреза для обработки импоста (алюминий) ALDOKS



(A2E) Фреза для обработки рамы



(A2E) Фреза для импоста



(A6V) Фреза для обработки импоста



Фреза для обработки створки



(A6V) Фреза для обработки рамы



(A1E) Фреза для обработки импоста



(A6V) Фреза для обработки импоста



(A1E) Фреза для обработки импоста



(AV8) Фреза для обработки импоста



(A2E) Фреза для обработки створки



Фреза для обработки створки двери



Цулага для штапика Universal

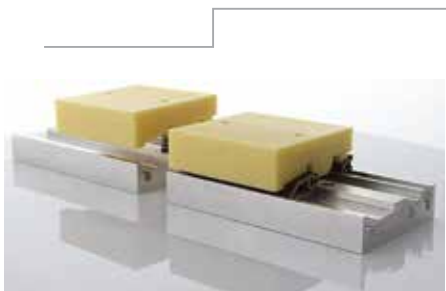

Цулага для штапика Kaban



Цулага для штапика Yilmaz



Цулага для штапика Murat



Цулага для сварочного станка



Цулага для сварочного станка



Цулага для сварочного станка

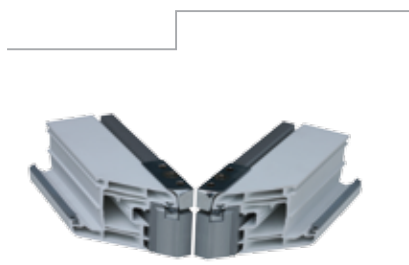

Цулага для сварочного станка

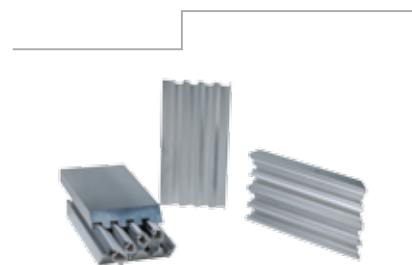

Набор цулаг для штапикореза

KC 258

MURAT



175X335 MM

KC 258

MURAT



215X335 MM

KC 272

MURAT



155X300 MM

KB 512

MURAT



155X300 MM

KD 658

MURAT



215X300 MM

KB 512/KC 272

MURAT



215X300 MM

KD 655

MURAT



215X300 MM

KD 655-1

MURAT



215X300 MM

KC 258

MURAT



215X330 MM

EL 001

STÜRTZ, ELUMATEC



290X213 MM

ES 710/ES 601/ZS 720

ELUMATEC



300X340 MM

**BD2030 / BD2100
BD2010 / FA1040**

KABAN



225X220 MM

BB2030/MA2010

KABAN



225X315 MM

BB2020-1/BA2020

KABAN



225X360 MM

BD 2010

KABAN



230X290 MM

AKS 3900

URBAN



236X338 MM

TK 501

YILMAZ



240X240 MM

DK 502

YILMAZ



220X270 MM

FRZ 001

FORZA / SAWIN



200X255 MM

OZ 01

ÖZÇELİK



238X185 MM

OZ 02

ÖZÇELİK



266X202 MM

OZ 03

HOLLINGER



265X185 MM

OZ 04

URBAN



350X205 MM

OZ 05

ELUMATEC



Dört Kafa Paslanmaz Çene Sağ Sol
Quad Head Left Right

BD 2010

KABAN



20X26 MM

BA 2020

KABAN



26.5X26.5 MM

BB 2020-1

KABAN



26X26 MM

KC 258

MURAT



25X26.5 MM

ÖZÇELİK



25X24.5 MM

ÖZÇELİK



25X32 MM

ELUMATEC, STÜRTZ



21X16 MM

KD 658

MURAT



EN/W : 10 CM BOY / L: 5 CM

BD 2030

KABAN



EN/W : 20 CM BOY / L: 5 CM

MA 2010

KABAN



EN/W : 27 CM BOY / L: 4.5 M



Тefлоновая лента



Самоклеющаяся тefлоновая лента

BD 2010-MA2010

KABAN



EN/W : 22 CM BOY / L: 5 M

BD 2010-MA2010

KABAN



EN/W : 21.5 CM BOY / L: 5 M

BD 2010-MA2010

KABAN



EN/W : 18.7 CM BOY / L: 5 M

Пластина на 4х головый сварочный станок KC258



Пластина на 4х головый сварочный станок KB512

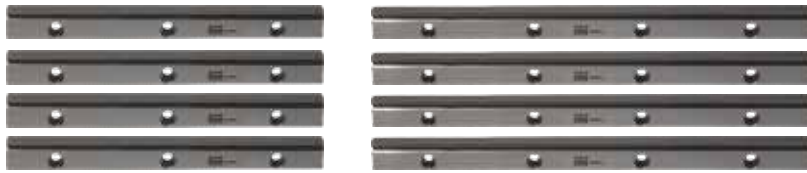

Пластина на 4х головый сварочный станок KD-655 KD658



TT 01

MURAT



TCR-M5.5-L030-K02.J M8

TT 02

MURAT



TC-M06-L030-K2,5.J M12

TT 03

MURAT



TC-M05-L030-K1 275.J YÜKSÜNLÜ 01

TT 04

MURAT



TC-06-L110-KD,90 J. 0200

TT 05

MURAT



TCR-M06-L30-K02.J M10J M8

TT 06

KABAN



BT01-1J06-3 O K60 T. SIZ

TT 07

KABAN



BT01-1J06-3 O K20 T. SIZ

TT 08

KABAN



BT01-1J06-3 O K30 T. SIZ

TT 09

YILMAZ



ETB30F06-1.5Ç

TT 10

ÖZÇELİK



ETB30F06-2S

TT 11

STÜRTZ ELUMATEC



MPB2-J103-2 1 K

TT 12

KABAN



BT01-1J06-3 O TOPRAKSIZ 4MT

TT 13

KABAN



BT01-1J06-3 O TOPRAKSIZ 8MT

TT 14

KABAN



BT01-1J06-3 O TOPRAKSIZ 12MT

TT 15

KABAN



BT01-1J06-3 O TOPRAKSIZ 10MT

TT 16

URBAN



MPB-ÖZEL 3 K

TT 17

HOLLINGER



CVK 01



Стеклорез алмазный

CVK 02



Стеклорез

CVK 03



Стеклорез

CVK 04



Стеклорез

CVK 05



40 cm, 80 cm, 120 cm

Циркуль с шестью режущими, роликами,
максимальный диаметр 400 -200 mm

CVK 06

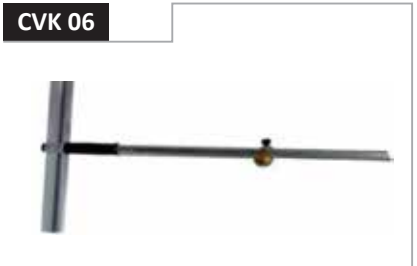

120 cm, 150 cm, 180 cm

Роликовый быстрорез для резки стекла

CVK 07



Кованные щипцы для мозаики

CVK 08



Вакуумная присоска для стекла
вертикальная грузоподъемность 60 kg
горизонтальная грузоподъемность 42 kg

CVK 09



Вакуумная присоска для стекла
с металлическим ручкой (двойная)
вертикальная грузоподъемность 200 kg
горизонтальная грузоподъемность 180 kg

CVK 10



Стандартная вакуумная
присоска (тройная)
вертикальная грузоподъемность 300 kg
горизонтальная грузоподъемность 250 kg

CVK 11



Вакуумная присоска для стекла
с металлическим основанием
вертикальная грузоподъемность 90 kg
горизонтальная грузоподъемность 70 kg

CVK 12



Вакуумная присоска для стекла
с металлическим основанием
вертикальная грузоподъемность 130 kg
горизонтальная грузоподъемность 100 kg

EA 55



Шланг для экструдера хотмелта

EA 46



Пистолет для хотмелта

EA 47



Пистолет для экструдера тиокола Graco

EA 56



Пистолет для экструдера тиокола (Турция)

CVK 13



Вакуумная присоска для стекла
с металлическим основанием
вертикальная грузоподъемность 150 kg
горизонтальная грузоподъемность 130 kg

CVK 14



Вакуумная присоска для стекла
с металлическим основанием
вертикальная грузоподъемность 190 kg
горизонтальная грузоподъемность 170 kg

CVK 15



Вакуумная присоска для стекла 8''(203mm)
Грузоподъемность 240 kg
Для листового стекла

CVK 16



Вакуумная присоска для стекла 10''(254mm)
Грузоподъемность 300 kg
Для листового стекла

CVK 17



Вакуумная присоска для стекла 10''(254mm)
Грузоподъемность 300 kg
Для овального стекла

CVK 18



Вакуумная присоска для стекла 10''(254mm)
Грузоподъемность 305 kg
Присоски для овального и горячего стекла

EA 03



EA 06



YP 03



TC4420 Dijital Termostat 48x48

EA 51



YP 26



4V220-08 1/4-5/2 - 24VDC

YP 16



YP 17



OFR-1/4 Regulator

EA 27



YP 25



4V220-08 1/4-5/2 - 24VDC

YP 15



FV-320 1/4-3/2

EA 49



YP 35



EA 28



OPT 232



OPT 4080



HT 01



YP 44

FESTO



SME-8M-24V-
8028518

YP 42

SICK



RZT-1 03ZUS-KW
1025380

EA 22



EA 02



EA 37



OPT 3042



1/2"
20u
05-9.9 atü
5-60°C
80 ml
2200 lt/dk

EA 31



EA 32



EA 33



AP 01

KÖNIG TOOLS



Устройство для зачистки поверхности

AP 04

KÖNIG TOOLS



Пневматический аппарат для зачистки
внутреннего угла

AP 06

KÖNIG TOOLS



Станок для фрезерования
водоотливных каналов

AP 15

KÖNIG TOOLS



Дренажный аппарат

AP 03

KÖNIG TOOLS



Механический аппарат для
зачистки углов

AP 05

KÖNIG TOOLS



Пневматический аппарат для
зачистки наружного угла

AP 07

KÖNIG TOOLS



Автоматический станок для
зачистки поверхности с одной стороны

AP 16

KÖNIG TOOLS



Аппарат тройного сверления
6x10x107
6x13x110

TTS 101



132 KG
620 x 740 x 1350

TTS 201



103 KG
1060 x 500 x 1000

TTS 301



65 KG
710 x 450 x 1115

TTS 401



108 KG
630 x 630 x 1230

TTS 402



320 KG
1000 x 1460 x 1460

TTS 501



160 KG
1000 x 700 x 1380

TTS 601



115 KG
620 x 920 x 1400

TTS 111



140 KG
620 x 740 x 1350

TTS 101A



22 KG
670 x 500 x 520

TTS 631



38 KG
600 x 430 x 650

TTS 321



38 KG
495 x 340 x 500

TT 300



30 KG
400 x 620 x 415

TTS 701



TTS 801



